

## SPICE thermal model

BUK954R4-80E

Symbol	Parameter	Conditions	Min	Typ	Max	Unit
$R_{th(j-mb)}$	thermal resistance from junction to mounting base		-	-	0.43	K/W

$C_{th1}$	2.727E-04 F
$C_{th2}$	1.961E-03 F
$C_{th3}$	1.472E-03 F
$C_{th4}$	5.515E-03 F
$C_{th5}$	1.889E-02 F
$C_{th6}$	3.370E-02 F
$C_{th7}$	7.373E-01 F
$C_{th8}$	2.812E+02 F
$R_{th1}$	3.269E-04 $\Omega$
$R_{th2}$	6.428E-04 $\Omega$
$R_{th3}$	7.505E-03 $\Omega$
$R_{th4}$	1.817E-02 $\Omega$
$R_{th5}$	6.176E-02 $\Omega$
$R_{th6}$	2.678E-01 $\Omega$
$R_{th7}$	7.287E-02 $\Omega$
$R_{th8}$	6.467E-04 $\Omega$

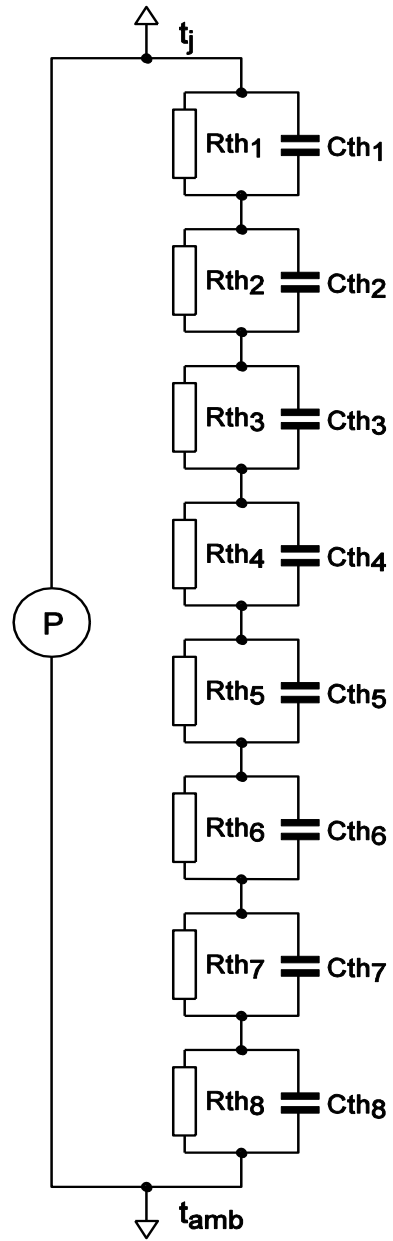

Part: BUK954R4-80E  
 Date: 17/4/2013  
 Model Rth 0.43 K/W